

Product Summary

V_{RRM}	650	V
$I_F @ T_C=135^{\circ}C$	8	A
$Q_C @ V_R=400V$	23	nC

TO-220AC

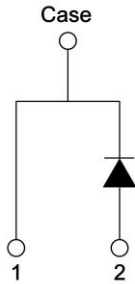
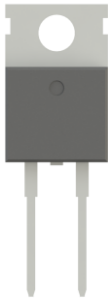

Features

- Negligible reverse recovery
- High surge current
- Positive temperature coefficient
- Pb-free lead plating and halogen-free

Marking

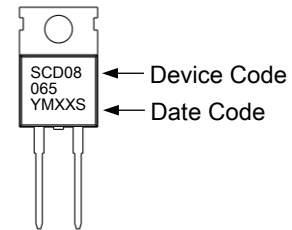

YMXX: Date Code Marking

Y: Year Code, the last digit of Christian year

M: Month Code

A: Jan	B: Feb	C: Mar	D: Apr	E: May	F: Jun
G: Jul	H: Aug	J: Sep	K: Oct	L: Nov	M: Dec

XX: Production Serial Number, 01~99

S: Assembly site code, Site 1: A

Ordering Information

Device	Package	Shipping
SCD08065E2-0-UB-G	TO-220AC	50 pcs/tube, 20 tubes/box, 5 boxes / carton

0: Product rank, zero for no rank products.

UB: Packing spec, UB : 50 pcs / tube, 20 tubes/box

G: Environment friendly grade: S for RoHS compliant products, G for RoHS compliant and green compound products.

Absolute Maximum Ratings ($T_A=25^{\circ}C$)

Parameter	Symbol	Value	Unit	
Repetitive Peak Reverse Voltage	V_{RRM}	650	V	
Continuous Forward Current @ $T_C=25^{\circ}C$	I_F	16.9	A	
Continuous Forward Current @ $T_C=116^{\circ}C$		10		
Continuous Forward Current @ $T_C=135^{\circ}C$		8		
Non-repetitive Forward Surge Current @ $T_C=25^{\circ}C$	*a I_{FSM}	64		
I^2t limit Value @ $T_C=25^{\circ}C$, $t_p=10ms$	I^2t	20.5	A^2s	
Total Power Dissipation	P_D	$T_C=25^{\circ}C$	79	W
		$T_C=110^{\circ}C$	34	
		$T_A=25^{\circ}C$ *b	6.5	
		$T_A=110^{\circ}C$ *b	2.8	
Operating Junction and Storage Temperature Range	T_J, T_{stg}	-55~+175	$^{\circ}C$	
Steady State Thermal Resistance, Junction-to-Case	$R_{\theta JC}$	1.9	$^{\circ}C/W$	
Steady State Thermal Resistance, Junction-to-Ambient	*b $R_{\theta JA}$	23		

Electrical Characteristics ($T_J=25^{\circ}\text{C}$, unless otherwise specified)

Symbol	Min.	Typ.	Max.	Unit	Test Conditions
Static					
V_R	650	-	-	V	$I_R=50\mu\text{A}$
V_F	-	1.39	1.6	V	$I_F=8\text{A}$, $T_J=25^{\circ}\text{C}$
	-	1.86	-		$I_F=8\text{A}$, $T_J=175^{\circ}\text{C}$
I_R	-	0.82	50	μA	$V_R=650\text{V}$, $T_J=25^{\circ}\text{C}$
	-	5	-		$V_R=650\text{V}$, $T_J=175^{\circ}\text{C}$
Dynamic					
C_J	-	430	-	pF	$V_R=0\text{V}$, $f=1\text{MHz}$
	-	49	-		$V_R=200\text{V}$, $f=1\text{MHz}$
	-	43	-		$V_R=400\text{V}$, $f=1\text{MHz}$
Q_C	-	23	-	nC	$V_R=400\text{V}$, $f=1\text{MHz}$
E_C	-	3.7	-	μJ	$V_R=400\text{V}$, $f=1\text{MHz}$

Note:

- *a. Square wave, $t_p=10\text{ms}$.
- *b. The value of $R_{\theta JA}$ is measured with the device mounted on 1in^2 FR-4 board with 2oz copper, in a still air environment with $T_A=25^{\circ}\text{C}$. The value in any given application depends on the user's specific board design.
- *c. Pulse Test : Pulse Width $\leq 300\mu\text{s}$, Duty Cycle $\leq 2\%$.

Typical Characteristics

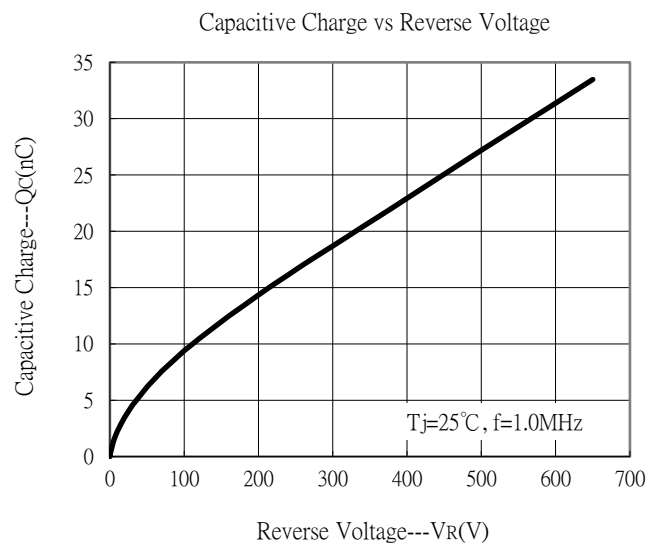
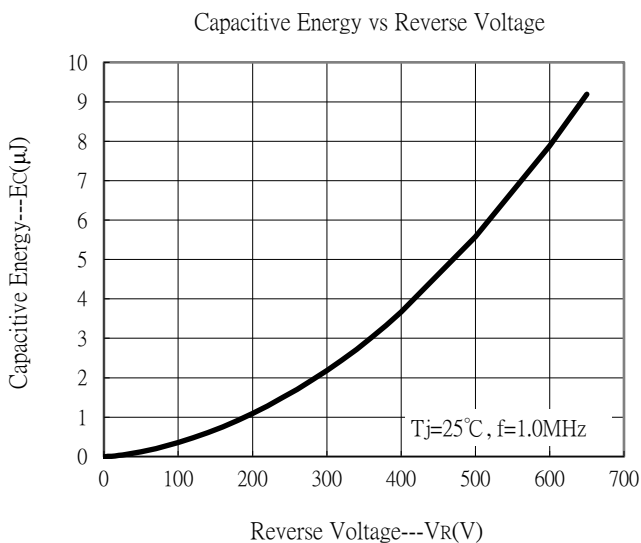
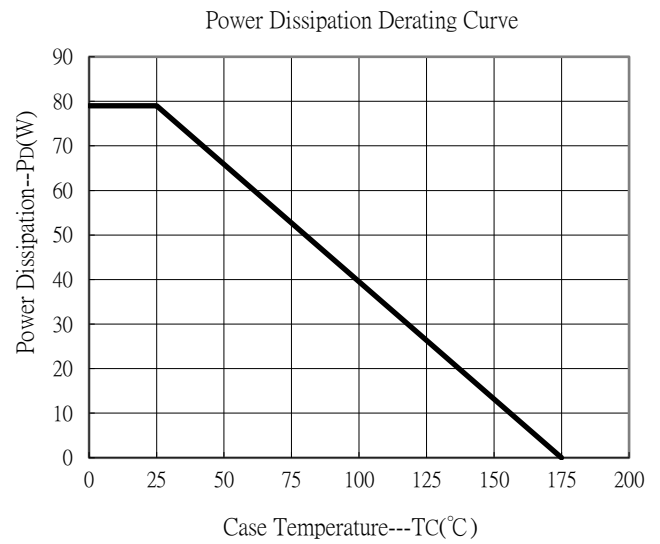
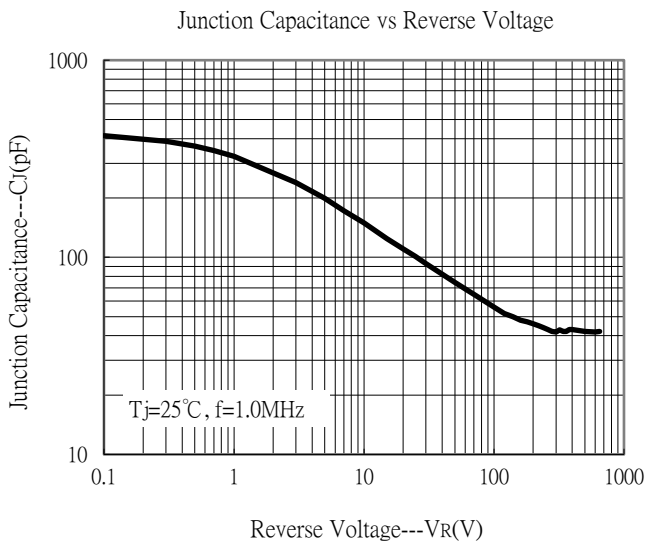
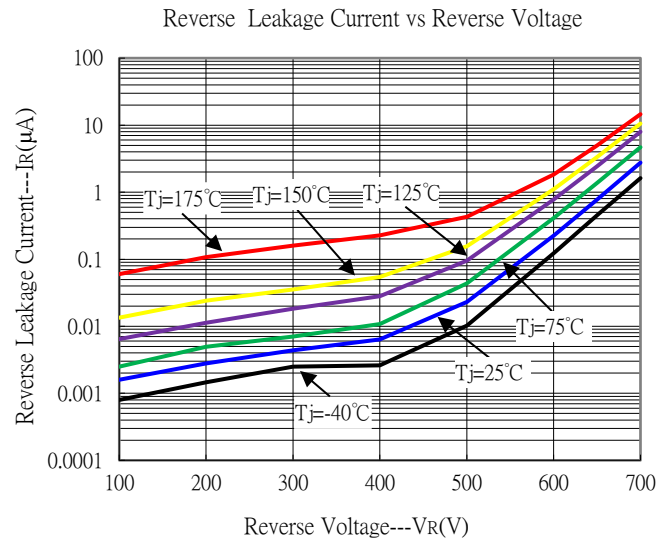
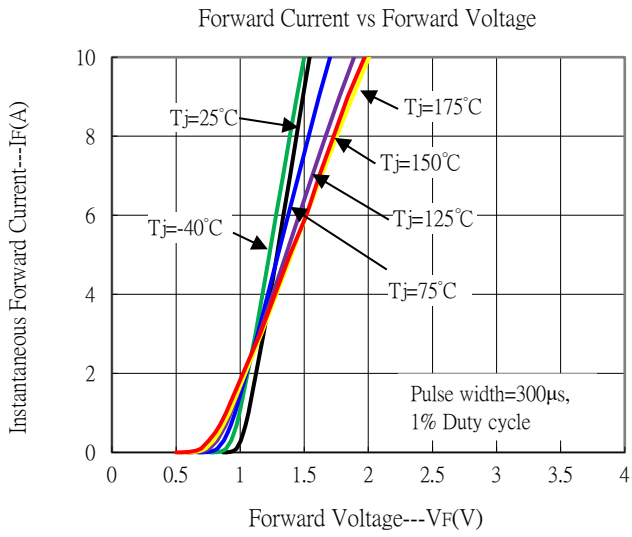

Typical Characteristics (Cont.)

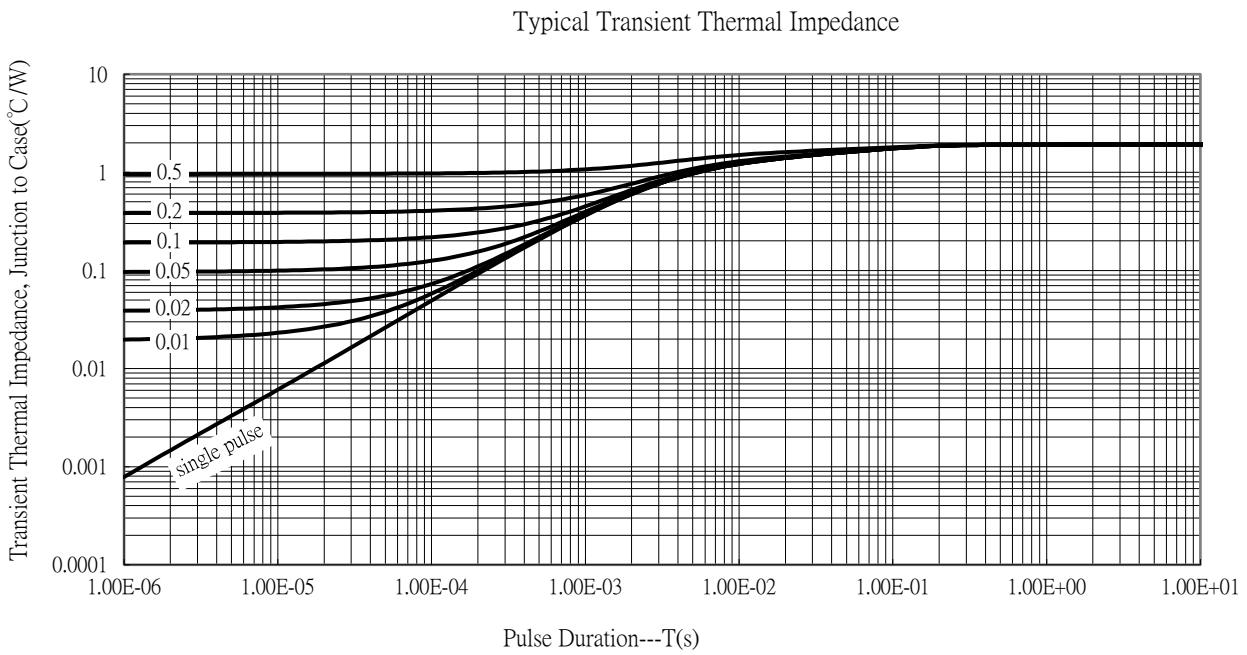
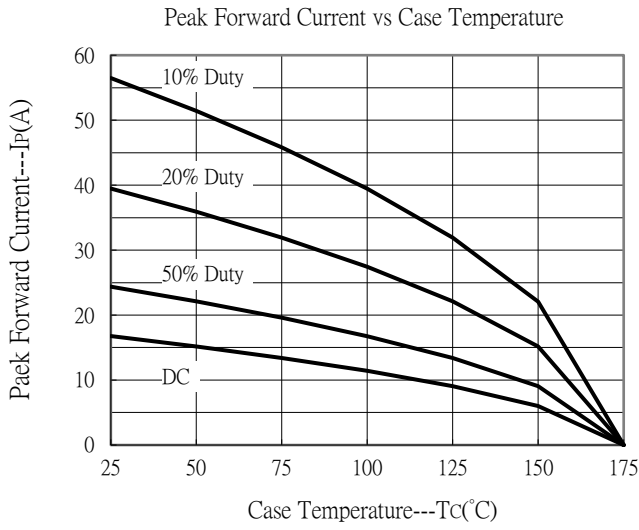

TO-220AC Dimension

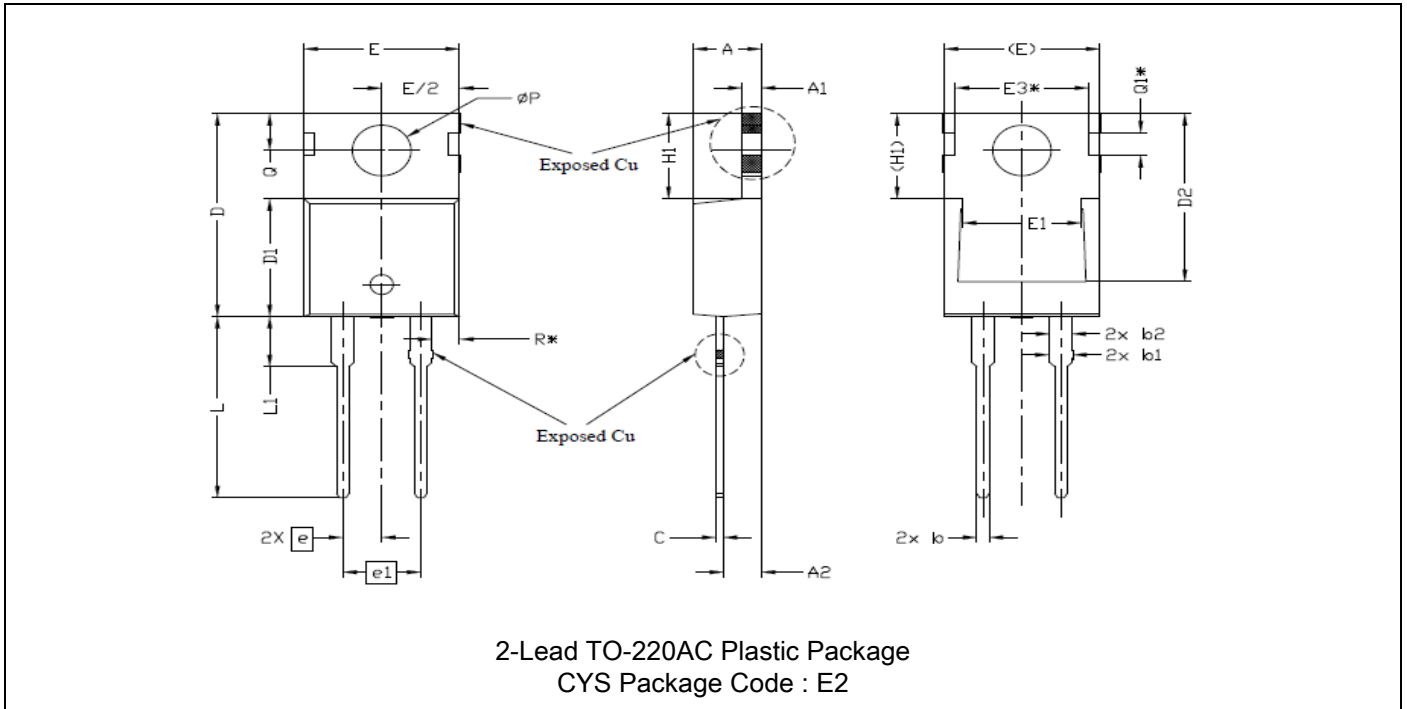

DIM	Millimeters		Inches		DIM	Millimeters		Inches	
	Min.	Max.	Min.	Max.		Min.	Max.	Min.	Max.
A	4.24	4.64	0.167	0.183	E1	6.86	8.89	0.270	0.350
A1	1.15	1.40	0.045	0.055	E3*	8.70 REF		0.343 REF	
A2	2.30	2.70	0.091	0.106	e	2.54 BSC		0.100 REF	
b	0.70	0.90	0.028	0.035	e1	5.08 BSC		0.200 REF	
b1	1.20	1.75	0.047	0.069	H1	6.30	6.60	0.248	0.260
b2	1.20	1.70	0.047	0.067	L	13.47	13.97	0.530	0.550
c	0.40	0.60	0.016	0.024	L1	3.60	4.00	0.142	0.157
D	14.70	16.00	0.579	0.630	ΦP	3.75	3.93	0.148	0.155
D1	8.82	9.02	0.347	0.355	Q	2.60	3.00	0.102	0.118
D2	12.63	12.83	0.497	0.505	Q1*	1.73 REF		0.068 REF	
E	9.96	10.36	0.392	0.408	R*	1.82 REF		0.072 REF	

Note:

- “*” is reference.
- Controlling dimension: millimeters.
- Maximum lead thickness includes lead finish thickness, and minimum lead thickness is the minimum thickness of base material.
- If there is any question with packing specification or packing method, please contact your local CYStek sales office.

Material:

- Lead: pure tin plated.
- Mold Compound: Epoxy resin family, flammability solid burning class: UL94V-0.

Important Notice:

- All rights are reserved. Reproduction in whole or in part is prohibited without the prior written approval of CYStek.
- CYStek reserves the right to make changes to its products without notice.
- CYStek semiconductor products are not warranted to be suitable for use in Life-Support Applications, or systems.
- CYStek assumes no liability for any consequence of customer product design, infringement of patents, or application assistance.

Recommended wave soldering condition

Product	Peak Temperature	Soldering Time
Pb-free devices	260 +0/-5 °C	5 +1/-1 seconds

Recommended temperature profile for IR reflow

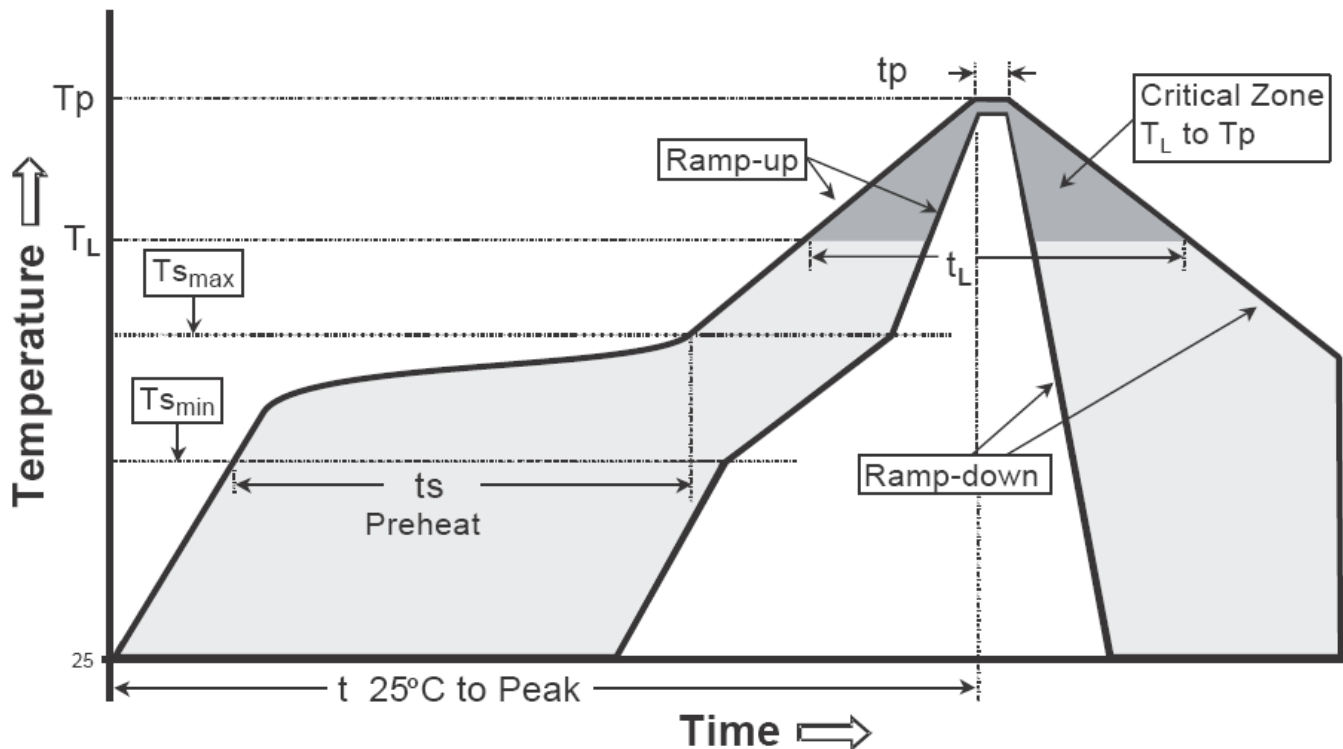

Profile feature	Sn-Pb eutectic Assembly	Pb-free Assembly
Average ramp-up rate (T _{smax} to T _p)	3°C/second max.	3°C/second max.
Preheat		
-Temperature Min(T _{s min})	100°C	150°C
-Temperature Max(T _{s max})	150°C	200°C
-Time(t _{s min} to t _{s max})	60-120 seconds	60-180 seconds
Time maintained above:		
-Temperature (T _L)	183°C	217°C
- Time (t _L)	60-150 seconds	60-150 seconds
Peak Temperature(T _P)	240 +0/-5 °C	260 +0/-5 °C
Time within 5°C of actual peak temperature(t _p)	10-30 seconds	20-40 seconds
Ramp down rate	6°C/second max.	6°C/second max.
Time 25 °C to peak temperature	6 minutes max.	8 minutes max.

Note : All temperatures refer to topside of the package, measured on the package body surface.